

modum<sup>®</sup>  
ITALIAN COMFORTABLE FASHION

---

by **Telcom**<sup>®</sup>

2018



modum®  
ITALIAN COMFORTABLE FASHION

# 2018collection

INDOOR · OUTDOOR · DESIGN

# FURNITURE

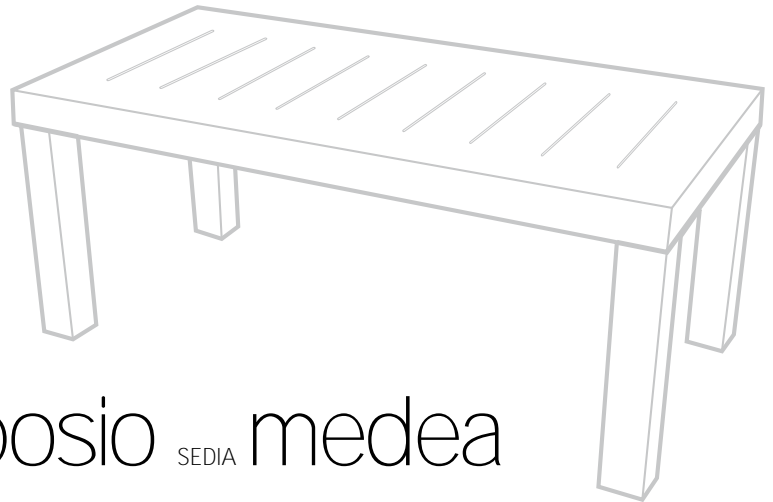

4-7

TAVOLO **simposio** SEDIA **medea**

8-9

DIVANO / POLTRONA **cairo** LAMPADA / TAVOLINO **diamante**

10-11

POLTRONA / DIVANO **caracas** TAVOLINO **tobago**

12-13

DIVANO / POLTRONA **miami** TAVOLINO **etoile**

14-15

DIVANO **acapulco** TAVOLINO **trinidad**

POLTRONA **panama**



16

TRONETTO **maui**

17

POLTRONA MULTIPOSIZIONE **bangkok**

18

DONDOLO **samarcanda**

19

POLTRONA **jamaica**



20 SEDIA tahiti TAVOLINO tobago

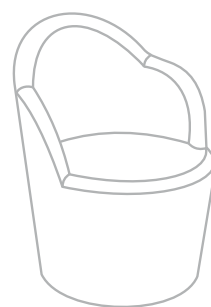

21 POLTRONA manila TAVOLINO tobago

22-23 SEDUTA bikini

24-25 CHAISE LONGUE copacabana

26-27 SEDUTA COMPONIBILE onda

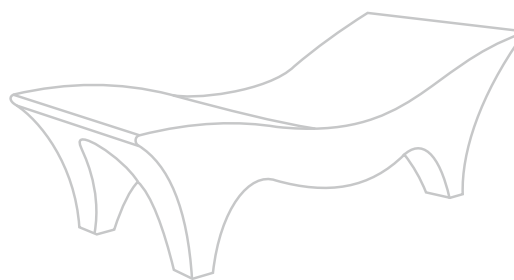

28-29 DORMEUSE le mans

30 LIBRERIA / DESK mensula

31 SCAFFALE wally

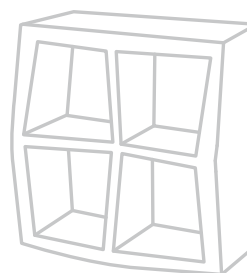

32 SCAFFALE window

33 SCRITTOIO descus SEDIA sophia

34 TAVOLINO / SEDUTA tunisi

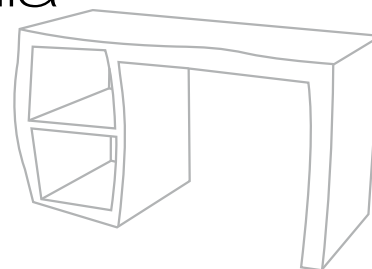

35 POUF tabasco

36 TAVOLINO scalea

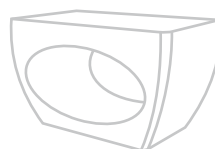

37 TAVOLINO SALOTTO curaçao LAMPADA/APPENDIABITI merlino

38-39 BAULE belize



# simposio *new*

TAVOLO / TAVOLO BASSO  
Indoor · Outdoor

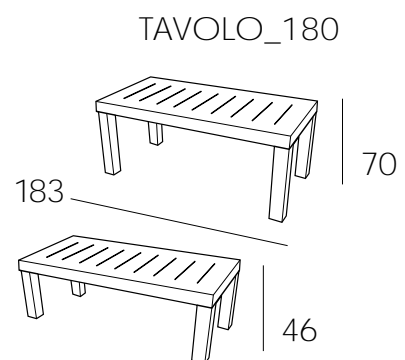



# medea *new*

SEDIA / SEDIA CON BRACCIOLI  
Indoor · Outdoor

SEDIA\_80

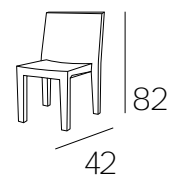







*new*  
medea

SEDIA / SEDIA CON BRACCIOLI  
Indoor · Outdoor



Impilabili



SEDIA\_80

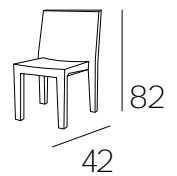

# cairo

POLTRONA / DIVANO  
Indoor · Outdoor

ILLUMINABILE 

PLTCR\_88

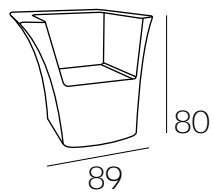

DVNCR\_160

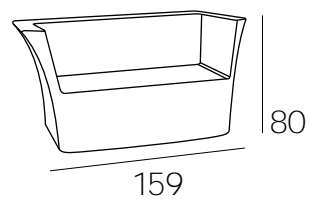



# diamante



LAMPADA / TAVOLINO

Indoor · Outdoor

CDMD (diverse misure disponibili)



ILLUMINABILE







# caracas

*(nella pagina a sinistra)*

POLTRONA

Indoor · Outdoor

PLTCA\_84

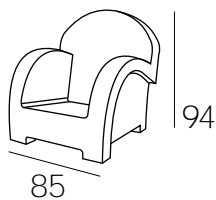

DIVANO

Indoor · Outdoor

DVNCA\_170

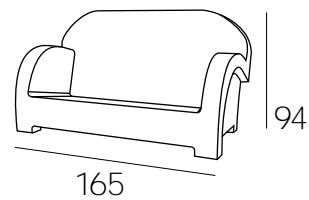

# miami

POLTRONA / DIVANO

Indoor · Outdoor

ILLUMINABILE 

PLTMA\_71

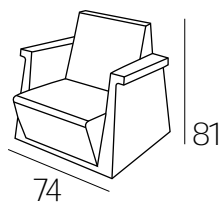

DVNMA\_150

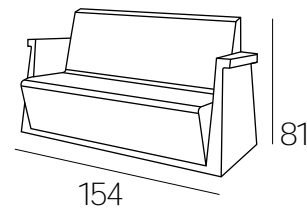

# etoile

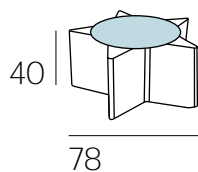

TAVOLINO

Indoor · Outdoor  
ETOILE\_80\_V

ILLUMINABILE 





acapulco





## trinidad

*(nella pagina a sinistra)*  
TAVOLINO

Indoor · Outdoor  
DP\_CMFS\_65\_V

ILLUMINABILE 

*(nella pagina a sinistra)*  
DIVANO 3 POSTI

Indoor · Outdoor  
DICOM\_175

 ILLUMINABILE

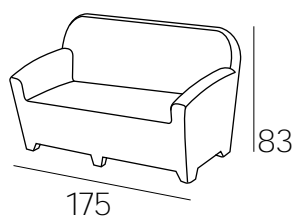

## panama

POLTRONA

Indoor · Outdoor  
POLCO\_78

ILLUMINABILE 

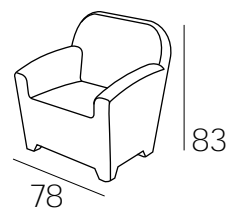
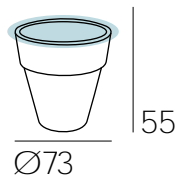

# maui

TRONETTO

Indoor · Outdoor

SETRO\_62

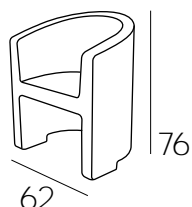

# tobago

TAVOLINO

Indoor · Outdoor

CLMD\_40

ILLUMINABILE 

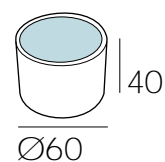



# bangkok

POLTRONA MULTIPOSIZIONE

Indoor · Outdoor

PLBK\_74

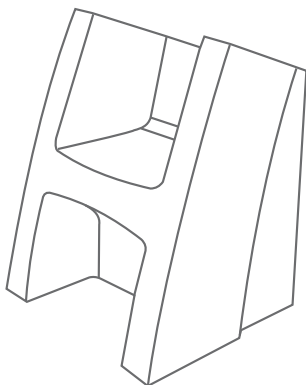

L. 74  
H. 81  
P. 67

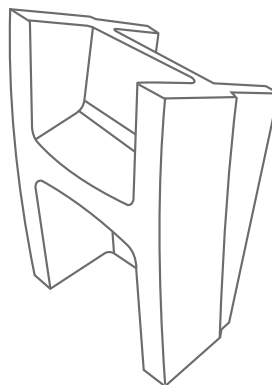

L. 74  
H. 81  
P. 67

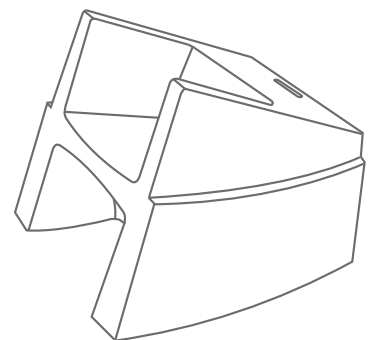

L. 74  
H. 67  
P. 81



samarcanda

DONDOLO  
Indoor · Outdoor  
PLDND\_77

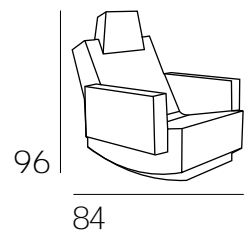

# jamaica

POLTRONA

Indoor · Outdoor  
PLJAM\_90

ILLUMINABILE 

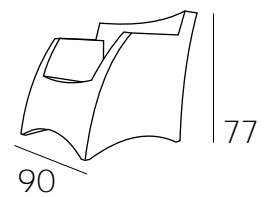



# tahiti

SEDIA

Indoor · Outdoor  
SEBRA\_67

ILLUMINABILE 

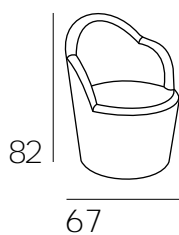

# tobago

TAVOLINO

Indoor · Outdoor  
CLMD\_65

ILLUMINABILE 

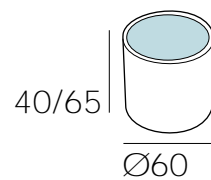

# manila

POLTRONA  
Indoor · Outdoor  
POMO\_74

ILLUMINABILE 

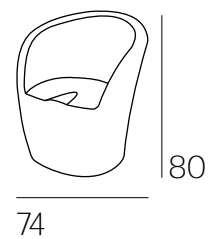





# bikini

SEDUTA IMPILABILE

Indoor · Outdoor  
PLBS\_111

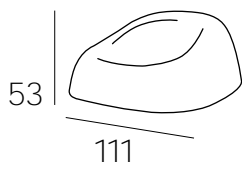

# copacabana





CHAISE LONGUE

Indoor · Outdoor

SPG\_184

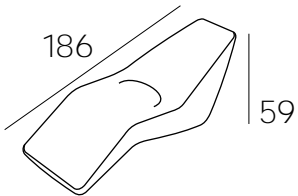



SEDUTA COMPONENTE

Indoor · Outdoor  
PSK\_80

ILLUMINABILE 

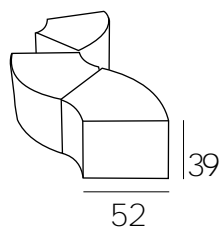

onda







# le mans

DORMEUSE

Indoor · Outdoor

CHMS\_78

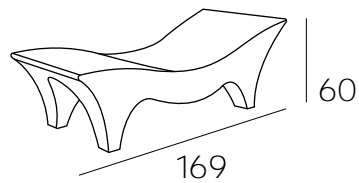

# mensula

LIBRERIA / DESK

Indoor · Outdoor

LBA\_83

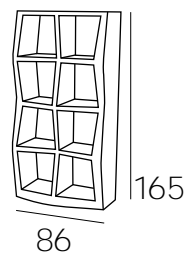





# wally

SCAFFALE

Indoor · Outdoor  
DSK\_50





# window

SCAFFALE

Indoor · Outdoor

LBA\_40



83

83

# sophia

SEDIA

Indoor · Outdoor

SDSK\_133

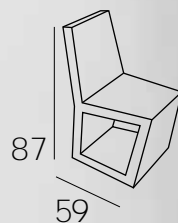

# descus

SCRITTOIO

Indoor · Outdoor

DSK\_133

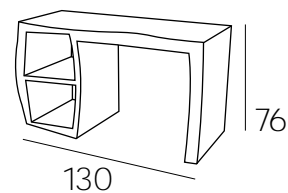

# tunisi

TAVOLINO / SEDUTA

Indoor · Outdoor

CILMU\_40

ILLUMINABILE 

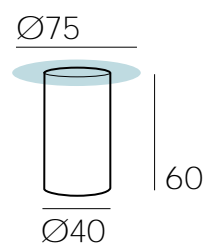

# tabasco

POUF

Indoor · Outdoor  
POUF\_60

💡 ILLUMINABILE

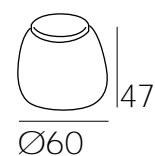



# scalea

TAVOLINO  
SPCT\_80

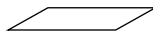
RIPIANO (a richiesta)  
RIP\_SPCT\_80 

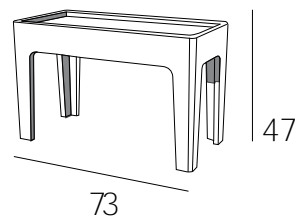

*new* curação

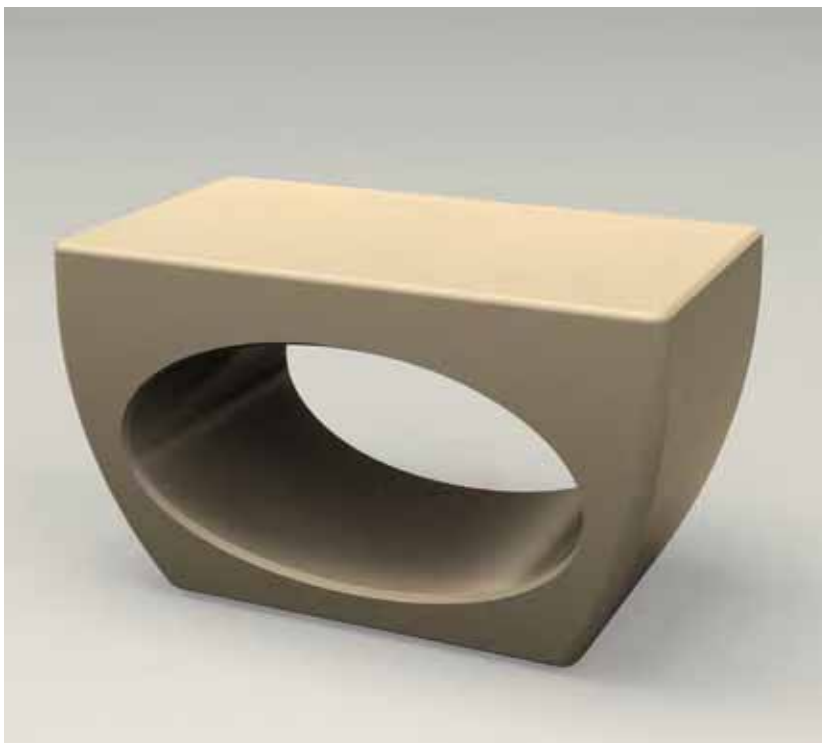

TAVOLINO DA SALOTTO  
TVBS\_75

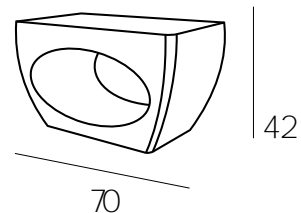

*new* merlino

LAMPADA/APPENDIABILI  
LMAB\_175  
LMAB\_175 SK

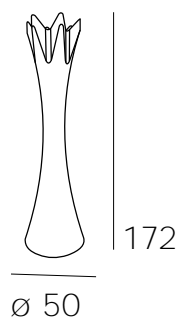





# belize



BAULE

Indoor · Outdoor  
BADN\_100

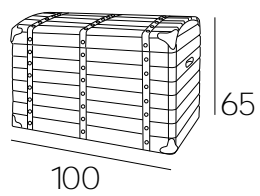

modum®  
ITALIAN COMFORTABLE FASHION

# PLANTERS

---

42-43 PORTAVASO santiago PORTAVASO cuba

44 PORTAVASO portorico 

45 PORTAVASO honolulu

46 PORTAVASO montero

47 PORTAVASO cozumel 

48-49 PORTAVASO manaus

50-51 PORTAVASO florida

52 PORTAVASO niagara 

53 PORTAVASO victoria

54 PORTAVASO bahamas

55 CALICE PORTAVASO gaudi

56-57 LIBRERIA / PORTAVASO flores VASO viareggio

58-59 PORTAVASO recife

60-61 PORTAVASO giza 

62-63 PORTAVASO dubai

64-65 PORTAVASO tolmezzo PORTAVASO tarvisio



# santiago

PORTAVASO

Indoor · Outdoor  
QLH\_PV\_80

 ILLUMINABILE

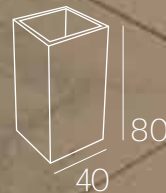



# cuba

PORTAVASO

Indoor · Outdoor  
CUBL\_PV\_50

ILLUMINABILE 

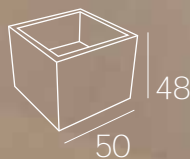



# portorico

PORTAVASO

Indoor · Outdoor  
VASNO\_75L

💡 ILLUMINABILE

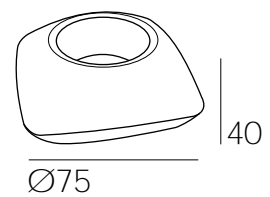



# honolulu

PORTAVASO

Indoor · Outdoor  
CVA\_PV\_90

ILLUMINABILE 

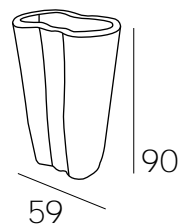

# montero



PORTAVASO

Indoor · Outdoor  
TROBO\_PV\_90

ILLUMINABILE 



90 - 110 - 130

Ø63





# cozumel

PORTAVASO

Indoor · Outdoor  
NOVOLO\_50

ILLUMINABILE 

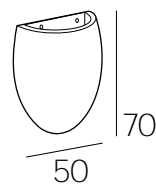



# manaus



PORTAVASO

Indoor · Outdoor  
COFA\_PV\_120

💡 ILLUMINABILE

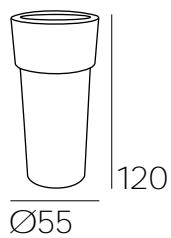





# florida

PORTAVASO

Indoor · Outdoor  
CDK\_PV\_110

ILLUMINABILE 

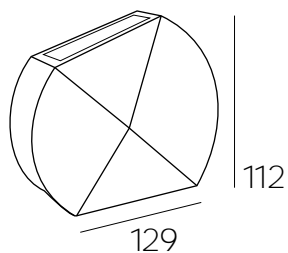

*(optional)*  
Portavaso per Florida  
CDK\_PV\_110\_VS

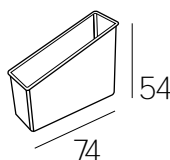



VASO QUADRUPLO

Indoor · Outdoor  
MLC\_95

niagara

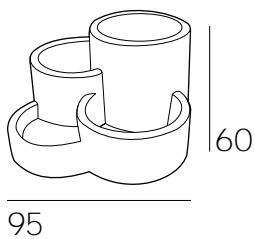



victoria

VASO QUADRUPLO

Indoor · Outdoor

MLQ\_74

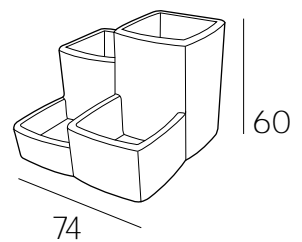

# bahamas

PORTAVASO

Indoor · Outdoor  
PRIBO\_PV\_120

💡 ILLUMINABILE

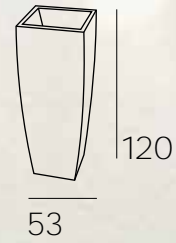



*new* gaudì



CALICE PORTAVASO

Indoor · Outdoor

CALGU\_90



ILLUMINABILE

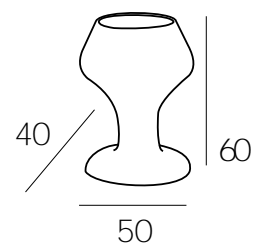

flores





# viareggio

*(optional)*

Vaso per Flores

Indoor · Outdoor

CUBL\_30

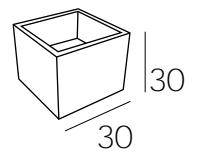

*(nella pagina a sinistra)*

PORTAVASO / LIBRERIA

Indoor · Outdoor

RBS\_PV\_30

💡 ILLUMINABILE

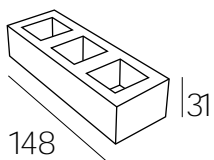





# recife

PORTAVASO

Indoor · Outdoor  
CRA\_PV\_105

ILLUMINABILE 

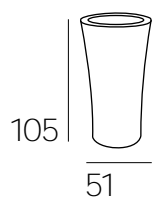



giza



PORTAVASO

Indoor · Outdoor  
PIFA\_PV\_105

 ILLUMINABILE

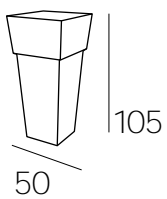





# dubai



PORTAVASO

Indoor · Outdoor  
CMFS\_85

ILLUMINABILE 

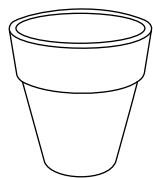

70 - 90 - 129

Ø65

Ø85

Ø118 non illuminabile



tolmezzo

PORTAVASO

Indoor · Outdoor  
VALPO\_PV\_60

ILLUMINABILE 

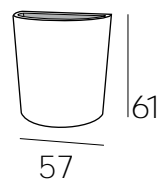



# tarvisio

PORTAVASO  
Indoor · Outdoor  
VALMO\_PV\_55

ILLUMINABILE 

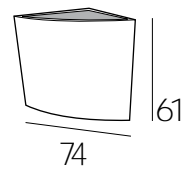

modum®  
ITALIAN COMFORTABLE FASHION

# LOUNGE FURNITURE

---

68

TAVOLINO ALTO margarita

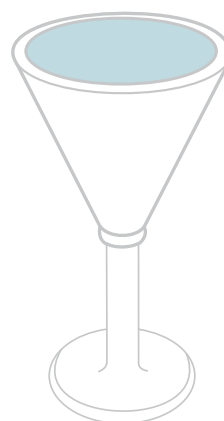

69

TAVOLINO BASSO martinica

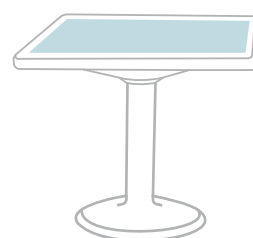

70-71

TAVOLINO ALTO wine

72-73

TAVOLINO BASSO antigua

74-75

TAVOLINO BASSO barbados

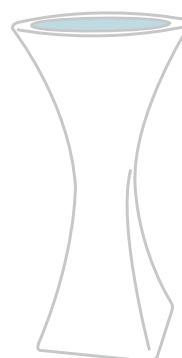

76-77

TAVOLINO ALTO brazil

78-79

BANCONE BAR robinson

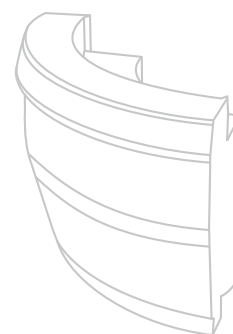

80-81

BANCONE BAR pemba

82-83

BANCONE BAR zanzibar

84-85

ESEMPI CONFIGURAZIONE zanzibar + pemba

86

ESPOSITORE BOTTIGLIE brillo

87

TAVOLINO ALTO hippy SGABELLO hippy



margarita



## TAVOLINO ALTO

Indoor · Outdoor  
MRG\_80 + GMB\_60

ILLUMINABILE 

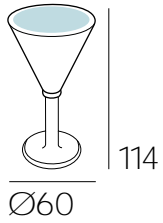

# martinica

## TAVOLINO BASSO

Indoor · Outdoor  
MRG\_60 + GMB\_60 B

ILLUMINABILE 

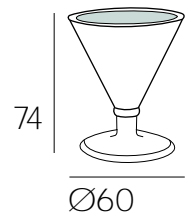

# diamante



LAMPADA / TAVOLINO

Indoor · Outdoor  
CDMD (diverse misure disponibili)

 ILLUMINABILE





wine



TAVOLINO ALTO  
Indoor · Outdoor  
VIN\_60 + GMB\_60  
ILLUMINABILE 

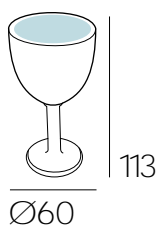



# antigua



## TAVOLINO BASSO

Indoor · Outdoor  
TVC\_80 + GMB\_60

ILLUMINABILE 

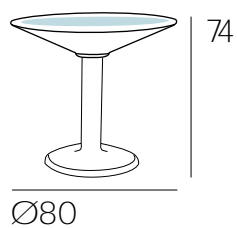



# barbados



TAVOLINO BASSO

Indoor · Outdoor  
TVQ\_80 + GMB\_60

ILLUMINABILE 

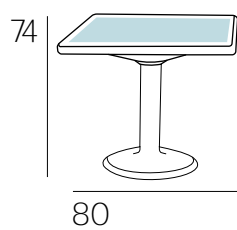

# brazil

TAVOLINO ALTO

Indoor · Outdoor  
TVLH\_110

ILLUMINABILE 

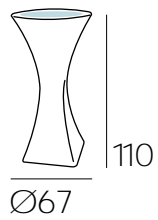



robinson







## BANCONE BAR

Indoor · Outdoor  
BNR\_120

💡 ILLUMINABILE

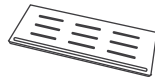
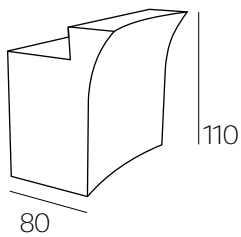

Ripiani a richiesta:  
RIP BN 107  
(L.107 H. 8 P. 39)  
*perni di fissaggio inclusi*

## salito

SGABELLO

Indoor · Outdoor  
SGB\_3870

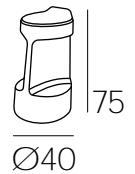

**new**

## BANCONE BAR WORKSTATION

Indoor · Outdoor  
BNR\_120 WS

ROBINSON Workstation con accessori in acciaio inox e vaschette in PP alimentare, in particolare:

- 4 vaschette da 0,75 litri in PP alimentare
- 2 vasche da 5 litri in acciaio inox
- 2 vasche da 9 litri in acciaio inox

tutte con relativo coperchio.







pemboa

BANCONE BAR  
Indoor · Outdoor  
BNA\_180

ILLUMINABILE 

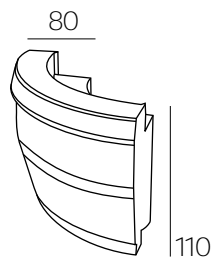



zanzibar

# salito

SGABELLO

Indoor · Outdoor

SGB\_3870

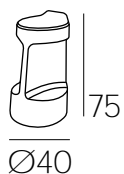

BANCONE BAR

Indoor · Outdoor

BNC\_170

💡 ILLUMINABILE

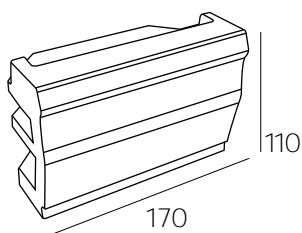

Ripiani superiori in PMMA inclusi  
2 PE shelves for worktops included



**new**

BANCONE BAR WORKSTATION

Indoor · Outdoor

BNC\_170 WS

ZANZIBAR Workstation con accessori in acciaio inox e vaschette in PP alimentare, in particolare:

- 4 vaschette da 0,75 litri in PP alimentare
  - 2 vasche da 5 litri in acciaio inox
  - 2 vasche da 9 litri in acciaio inox
- tutte con relativo coperchio.



## CONFIGURATION 1

2 Pemba + 1 Zanzibar



## CONFIGURATION 2

2 Zanzibar + 1 Pemba





CONFIGURATION 3

3 Pemba



CONFIGURATION 4

2 Pemba + 1 Zanzibar

*new* **brillo**

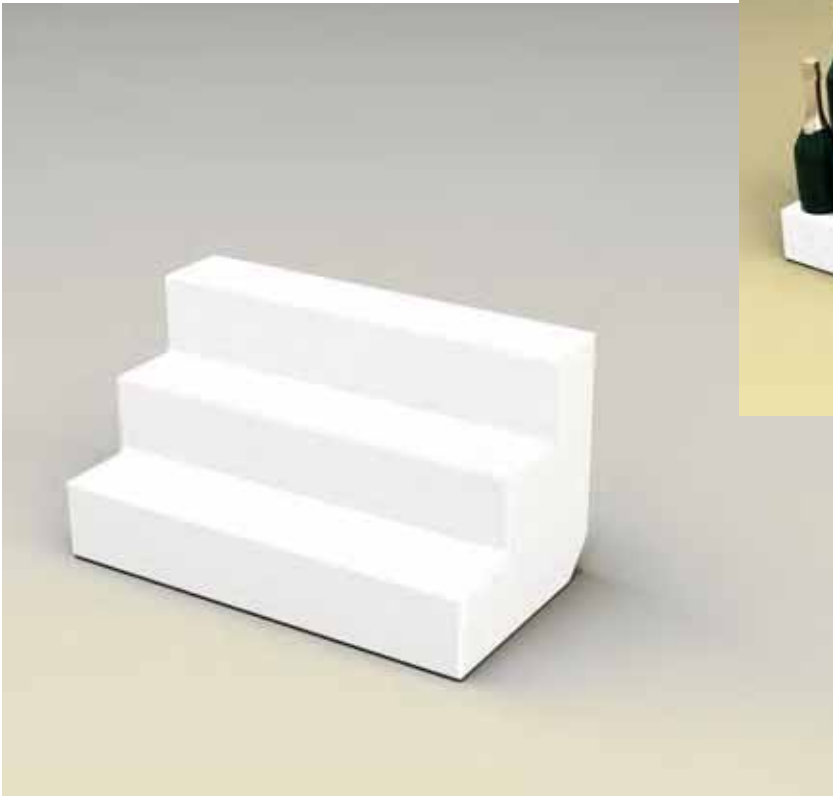

ESPOSITORE BOTTIGLIE

Indoor · Outdoor  
MENS\_15

ILLUMINABILE 

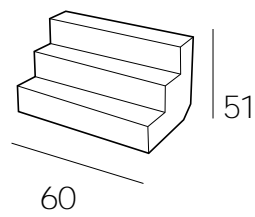



*new* hippy

Design: Marco Cocco



TAVOLINO ALTO

Indoor · Outdoor  
TVHP\_105

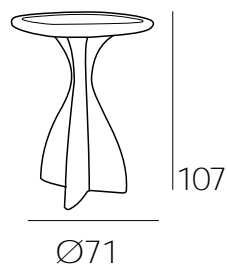

SGABELLO

Indoor · Outdoor  
SGL\_3681

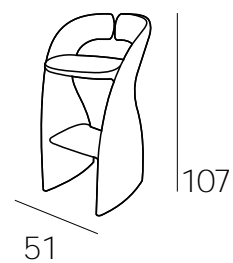

modum®  
ITALIAN COMFORTABLE FASHION

# LIGHT DESIGN

---

90

LAMPADA flute

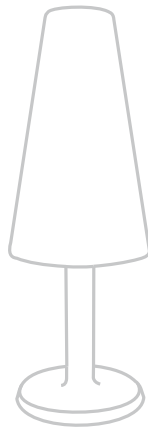

91

LAMPADA histoire

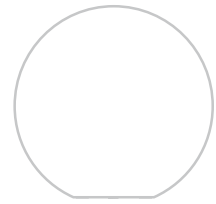

92-93

LAMPADA SFERICA A SOSPENSIONE/GALLEGGIANTE/BASE balux

94

LAMPADA A SOSPENSIONE/GALLEGGIANTE/CENTROTAVOLA vida

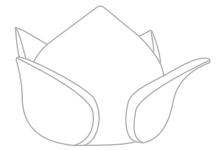

95

LAMPADA / APPLIQUE lucio

96-97

LAMPADA/TAVOLINO/LAMPADA A SOSPENSIONE sirio



98

LAMPADA lighthouse

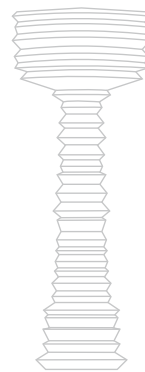

99

LAMPADA tower

100

LAMPADA andromeda

101

LAMPADA new york

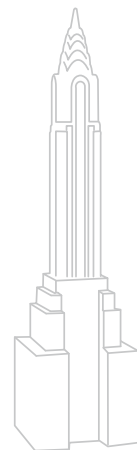

102

LAMPADA / CONTENITORE matera

# flute

LAMPADA

Indoor · Outdoor  
FLT\_43 + GMB\_76

💡 ILLUMINABILE



# histoire

LAMPADA

Indoor · Outdoor  
HST\_80 + GMB\_76

ILLUMINABILE 

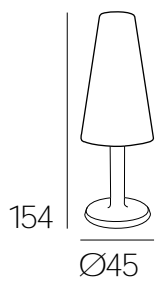



# balux

SFERA

Indoor · Outdoor  
SFM\_

 ILLUMINABILE

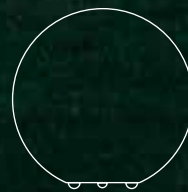

Ø30  
Ø40  
Ø50  
Ø70  
Ø90

# balux

LAMPADA a sospensione  
o galleggiante

Indoor · Outdoor  
SFM\_

💡 ILLUMINABILE

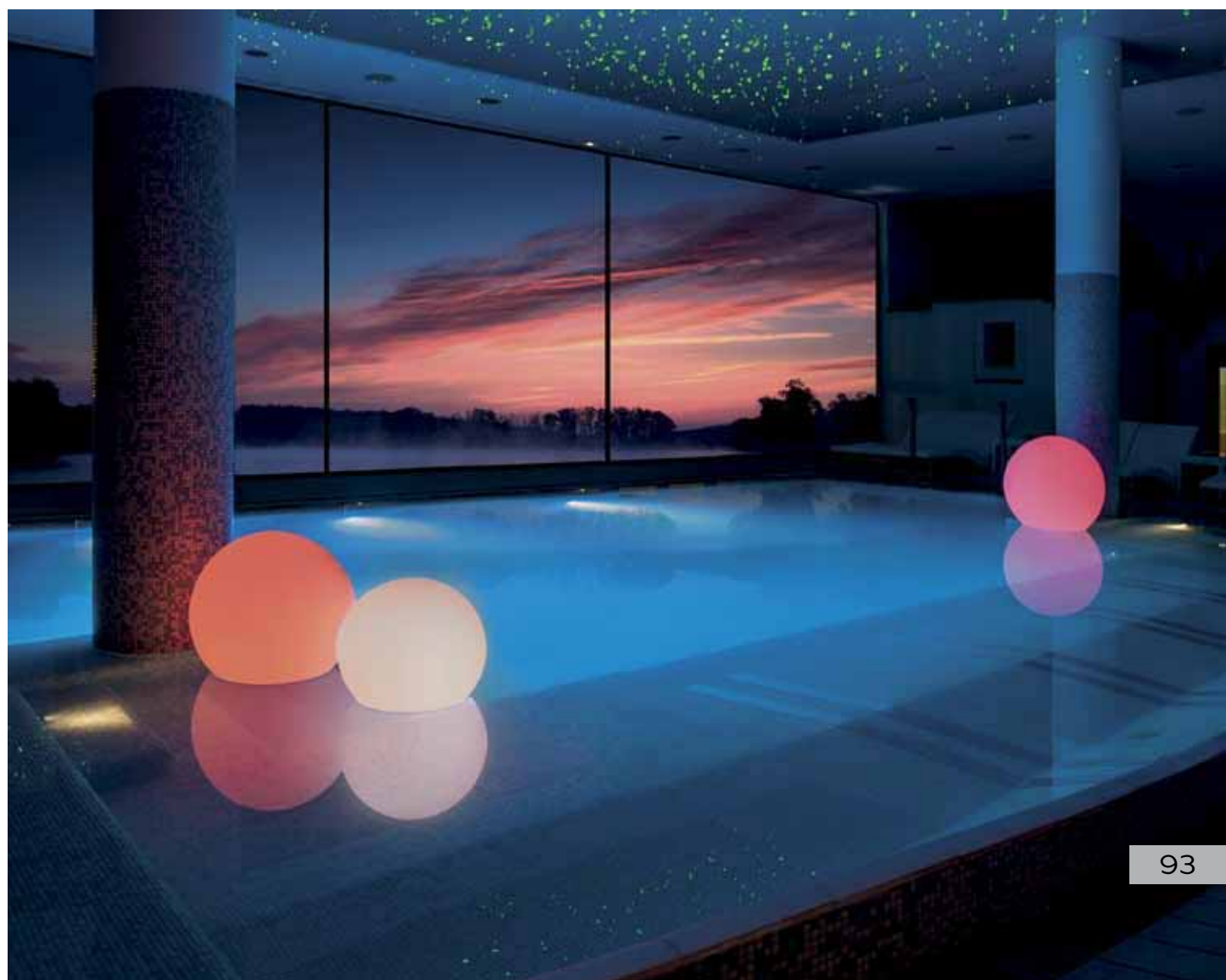
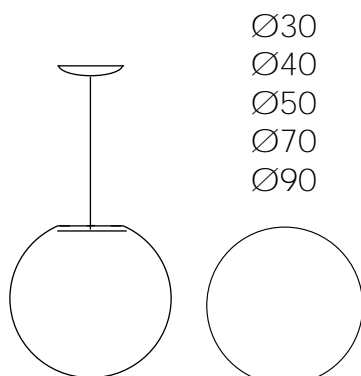



# vida

LAMPADA/CENTROTAVOLA

Indoor · Outdoor  
CNTA\_45

ILLUMINABILE 

Idoneo al galleggiamento

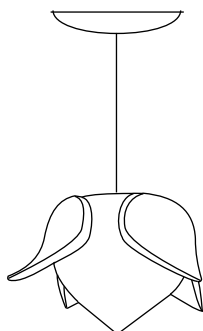
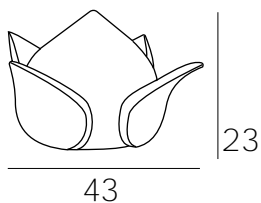





# lucio

LAMPADA / APPLIQUE

Indoor · Outdoor

APL\_40

 ILLUMINABILE

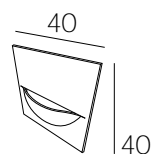

sirio

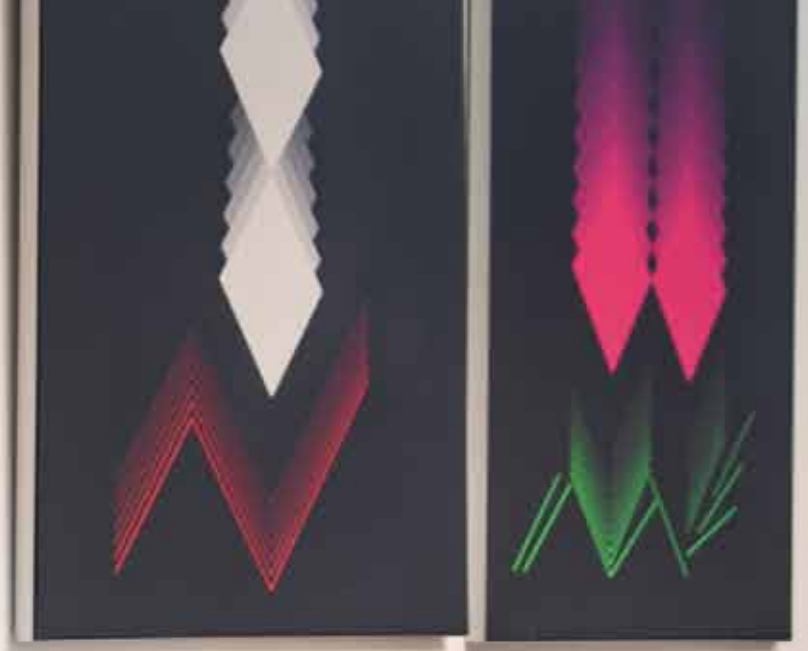



LAMPADA / TAVOLINO

Indoor · Outdoor

LMS\_60

💡 ILLUMINABILE

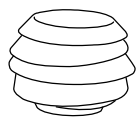

43

Ø60

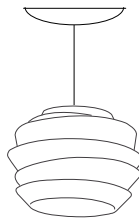

# lighthouse

LAMPADA

Indoor · Outdoor  
LTC\_180

ILLUMINABLE



# tower

LAMPADA

Indoor · Outdoor  
LTR\_180

ILLUMINABILE





# andromeda

LAMPADA

Indoor · Outdoor

LMTB\_140 + LMTS\_78

ILLUMINABILE 

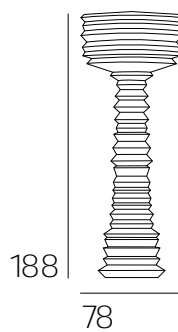



# new york

LAMPADA

Indoor · Outdoor  
LMGR\_180

ILLUMINABILE 

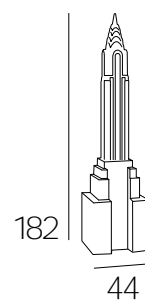



# matera

LAMPADA / CONTENITORE

Indoor · Outdoor  
SASSO\_3

 ILLUMINABILE

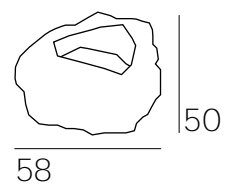



modum®  
ITALIAN COMFORTABLE FASHION

# ORNAMENT

INDOOR · OUTDOOR



104-105

SCULTURA olivo

106-107

SCULTURA alaska



108

SCULTURA peperone

109

SCULTURA venere di milo





# olivo

ALBERO ORNAMENTALE

Indoor · Outdoor  
ULIVO\_328

💡 ILLUMINABILE

*(Kit illuminazione non fornito)*

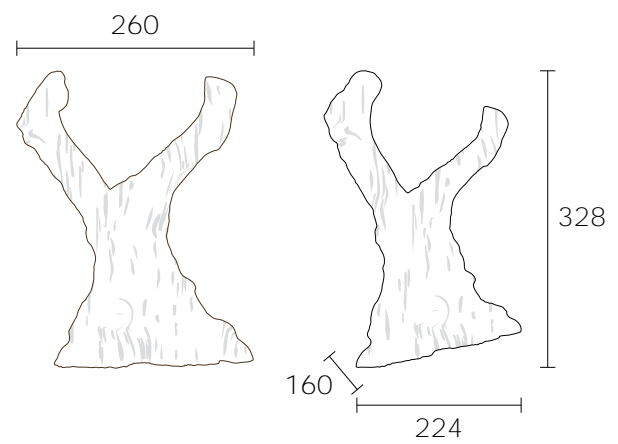



# alaska



SCULTURA

Indoor · Outdoor  
ALB\_110

ILLUMINABILE 

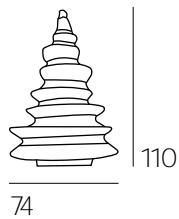

*(optional)*  
CASTEL VOLTURNO  
Base per Alaska  
PICLA\_40

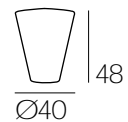

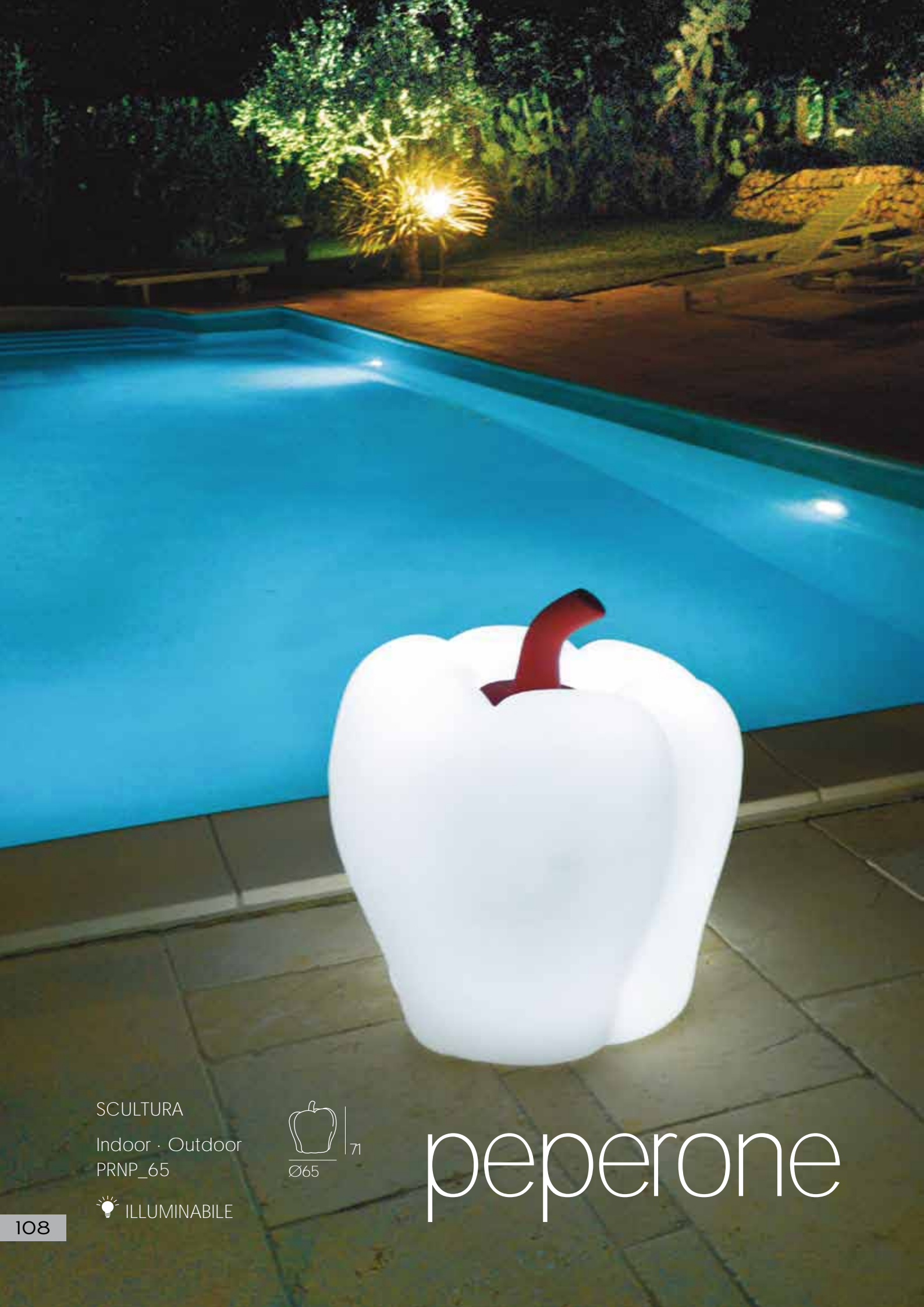

SCULTURA

Indoor · Outdoor  
PRNP\_65

 ILLUMINABILE



peperone

# venere di milo



SCULTURA

Indoor · Outdoor  
TR3

ILLUMINABILE 



54

104

# TECHNICAL DESCRIPTIONS



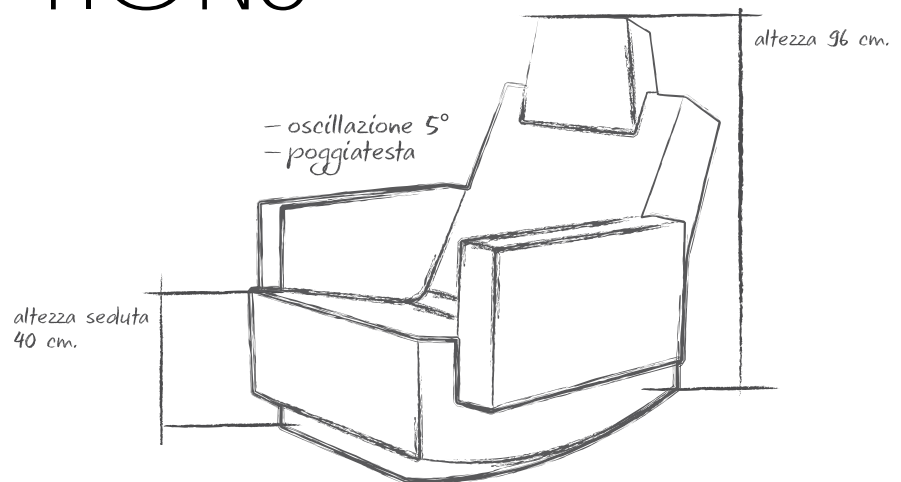







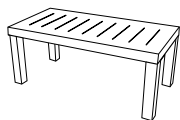



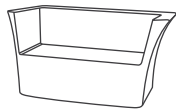



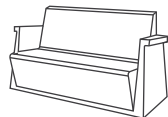

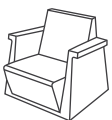

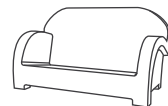



modum®  
ITALIAN COMFORTABLE FASHION





















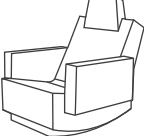







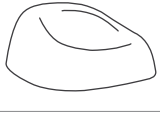

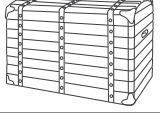

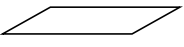



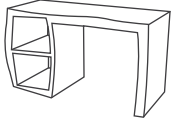





N.B. I dati e le immagini riportate in questo catalogo sono indicativi. La Telcom S.p.A. si riserva il diritto di apportare eventuali variazioni o migliorie agli articoli senza preavviso. Le misure sono espresse in centimetri con tolleranza del  $\pm 1\%$ .



# Furniture (pag. da 2 a 41)

| CODICE                                 | PRODOTTO                                     | DIMENSIONI (cm.)  |  | COLORE   | ILLUMINABILE             | IMBALLO   |
|--|--|---|--|--|--------------------------|---|
| TAVOLO 180<br>SET PAT 75<br>(pag. 4-7) | <b>SIMPOSIO</b><br>tavolo                    |    | L. 183<br>H. 70<br>P. 92   | ○ Bianco<br>N.B. Prodotto realizzabile a richiesta in qualsiasi colore (vedi pag. 125) | NO                       |    |
| SET PBT 52                             | (4 gambe basse)                              | /   | H. 46 (con piano)  |  |                          |   |
| SEDIA 80<br>(pag. 5-7)                 | <b>MEDEA</b><br>sedia                        |    | L. 42<br>H. 82 - H. seduta 43,5<br>P. 57                                 | ○ Bianco<br>N.B. Prodotto realizzabile a richiesta in qualsiasi colore (vedi pag. 125) | NO                       |    |
| Bracciolo 45 DX<br>Bracciolo 45 SX     | Braccioli per Sedia                          |    | /  |  |                          |   |
| DVNCR 160<br>(pag. 8-9)                | <b>CAIRO</b><br>divano                       |    | L. 159 - L. seduta 112<br>H. 80 - H. seduta 41<br>P. 83 - P. seduta 44   | ○ Neutro<br>N.B. Prodotto realizzabile a richiesta in qualsiasi colore (vedi pag. 125) | KIT LED 5<br>a richiesta |    |
| PLTCR 88<br>(pag. 8-9)                 | <b>CAIRO</b><br>poltrona                     |    | L. 89 - L. seduta 43<br>H. 80 - H. seduta 41<br>P. 83 - P. seduta 44     | ○ Neutro<br>N.B. Prodotto realizzabile a richiesta in qualsiasi colore (vedi pag. 125) | KIT LED 1<br>a richiesta |    |
| DVNMA 150<br>(pag. 12-13)              | <b>MIAMI</b><br>divano                       |   | L. 154 - L. seduta 127<br>H. 81 - H. seduta 39<br>P. 72 - P. seduta 40   | ○ Neutro<br>N.B. Prodotto realizzabile a richiesta in qualsiasi colore (vedi pag. 125) | KIT LED 5<br>a richiesta |   |
| PLTMA 71<br>(pag. 12-13)               | <b>MIAMI</b><br>poltrona                     |  | L. 74 - L. seduta 49<br>H. 81 - H. seduta 39<br>P. 72 - P. seduta 40     | ○ Neutro<br>N.B. Prodotto realizzabile a richiesta in qualsiasi colore (vedi pag. 125) | KIT LED 1<br>a richiesta |  |
| DVNCA 170<br>(pag. 10-11)              | <b>CARACAS</b><br>divano                     |  | L. 165 - L. seduta 136<br>H. 94 - H. seduta 29<br>P. 88 - P. seduta 55   | ○ Neutro<br>N.B. Prodotto realizzabile a richiesta in qualsiasi colore (vedi pag. 125) | NO                       |  |
| PLTCA 84<br>(pag. 10-11)               | <b>CARACAS</b><br>poltrona                   |  | L. 85 - L. seduta 55<br>H. 94 - H. seduta 29<br>P. 88 - P. seduta 55     | ○ Neutro<br>N.B. Prodotto realizzabile a richiesta in qualsiasi colore (vedi pag. 125) | NO                       |  |
| DICOM 175<br>(pag. 14-15)              | <b>ACAPULCO</b><br>divano                    |  | L. 175 - L. seduta 154<br>H. 83 - H. seduta 39<br>P. 67 - P. seduta 48,5 | ○ Neutro<br>N.B. Prodotto realizzabile a richiesta in qualsiasi colore (vedi pag. 125) | KIT LED 4<br>a richiesta |  |
| POLCO 78<br>(pag. 15)                  | <b>PANAMA</b><br>poltrona                    |  | L. 78 - L. seduta 51<br>H. 83 - H. seduta 39<br>P. 67 - P. seduta 48,5   | ○ Neutro<br>N.B. Prodotto realizzabile a richiesta in qualsiasi colore (vedi pag. 125) | KIT LED 1<br>a richiesta |  |
| PLBK 74<br>(pag. 17)                   | <b>BANGKOK</b><br>poltrona<br>multiposizione |  | L. 74 - L. seduta 52<br>H. 81 - H. seduta 44<br>P. 67 - P. seduta 35     | ○ Neutro<br>N.B. Prodotto realizzabile a richiesta in qualsiasi colore (vedi pag. 125) | NO                       |  |
|  |  |  | L. 74 - L. seduta 52<br>H. 81 - H. seduta 52<br>P. 67 - P. seduta 22     | ○ Neutro<br>N.B. Prodotto realizzabile a richiesta in qualsiasi colore (vedi pag. 125) | NO                       |  |
|  |  |  | L. 74 - L. seduta 52<br>H. 67 - H. seduta 37<br>P. 81 - P. seduta 36     | ○ Neutro<br>N.B. Prodotto realizzabile a richiesta in qualsiasi colore (vedi pag. 125) | NO                       |  |

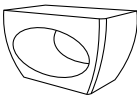
| CODICE                                   | PRODOTTO                                 | DIMENSIONI (cm.)  |  | COLORE   | ILLUMINABILE   | IMBALLO   |
|--|--|---|--|--|--|---|
| POMO 74<br>(pag. 21)                     | <b>MANILA</b><br>poltrona                |    | L. 74 - L. seduta 49<br>H. 80 - H. seduta 43<br>P. 70 - P. seduta 51   | ○ Neutro<br>N.B. Prodotto realizzabile a richiesta in qualsiasi colore (vedi pag. 125) | KIT LED 1<br>a richiesta                               |    |
| SEBRA 67<br>(pag. 20)                    | <b>TAHITI</b><br>sedia                   |    | L. 67 - L. seduta 49,5<br>H. 82 - H. seduta 44<br>P. 71 - P. seduta 52 | ○ Neutro<br>N.B. Prodotto realizzabile a richiesta in qualsiasi colore (vedi pag. 125) | KIT LED 1<br>a richiesta                               |    |
| PSK 80<br>(pag. 26-27)                   | <b>ONDA</b><br>seduta componibile        |    | L. 77 - L. seduta 77<br>H. 39 - H. seduta 39<br>P. 52 - P. seduta 52   | ○ Neutro<br>N.B. Prodotto realizzabile a richiesta in qualsiasi colore (vedi pag. 125) | KIT LED 1<br>oppure<br>KIT LED 1 RGB BT<br>a richiesta |    |
| SETRO 62<br>(pag. 16)                    | <b>MAUI</b><br>tronetto                  |    | L. 62 - L. seduta 45<br>H. 76 - H. seduta 43<br>P. 53 - P. seduta 43   | ○ Neutro<br>N.B. Prodotto realizzabile a richiesta in qualsiasi colore (vedi pag. 125) | NO   |    |
| PLJAM 90<br>(pag. 19)                    | <b>JAMAICA</b><br>poltrona               |    | L. 90 - L. seduta 55<br>H. 77 - H. seduta 39<br>P. 81 - P. seduta 43   | ○ Neutro<br>N.B. Prodotto realizzabile a richiesta in qualsiasi colore (vedi pag. 125) | KIT LED 1<br>a richiesta                               |    |
| PLDND 77<br>(pag. 18)                    | <b>SAMARCANDA</b><br>dondolo             |    | L. 78 - L. seduta 56<br>H. 96 - H. seduta 40<br>P. 84 - P. seduta 49   | ○ Neutro<br>N.B. Prodotto realizzabile a richiesta in qualsiasi colore (vedi pag. 125) | NO   |    |
| SPG 184<br>(pag. 24-25)                  | <b>COPACABANA</b><br>chaise longue       |  | L. 74 - L. seduta 58<br>H. 59 - H. seduta 29<br>P. 186 - P. seduta 55  | ○ Neutro<br>N.B. Prodotto realizzabile a richiesta in qualsiasi colore (vedi pag. 125) | NO   |  |
| CHMS 78<br>(pag. 28-29)                  | <b>LE MANS</b><br>dormeuse               |  | L. 78 - L. seduta 70<br>H. 60 - H. seduta 37<br>P. 169 - P. seduta 170 | ○ Neutro<br>N.B. Prodotto realizzabile a richiesta in qualsiasi colore (vedi pag. 125) | NO   |  |
| SGB 3870<br>(pag. 82-83)<br>(pag. 84-87) | <b>SALÌTO</b><br>sgabello                |  | Ø 40 - Ø seduta 35<br>H. 75 - H. seduta 70<br>P. 47 - P. seduta 35     | ○ Neutro<br>N.B. Prodotto realizzabile a richiesta in qualsiasi colore (vedi pag. 125) | NO   |  |
| PLBS 111<br>(pag. 22-23)                 | <b>BIKINI</b><br>seduta impilabile       |  | L. 111 - L. seduta 64<br>H. 53 - H. seduta 41<br>P. 111 - P. seduta 64 | ○ Neutro<br>N.B. Prodotto realizzabile a richiesta in qualsiasi colore (vedi pag. 125) | NO   |  |
| BADN 100<br>(pag. 38-39)                 | <b>BELIZE</b><br>baule                   |  | L. 100<br>H. 65<br>P. 55   | ● Legno<br>N.B. Colore disponibile solo per questo prodotto                            | NO   | IN BUSTA  |
| SPCT 80<br>(pag. 36)                     | <b>SCALEA</b><br>tavolino                |  | L. 73<br>H. 47<br>P. 35  | ○ Neutro<br>N.B. Prodotto realizzabile a richiesta in qualsiasi colore (vedi pag. 125) | NO   | IN BUSTA  |
| RIP SPCT 80<br>(pag. 36)                 | ripiano per<br>tavolino<br><b>SCALEA</b> |  | L. 75<br>H. 2<br>P. 37   | ○ Neutro<br>N.B. Prodotto realizzabile a richiesta in qualsiasi colore (vedi pag. 125) | NO   | IN BUSTA  |

| CODICE                   | PRODOTTO   | DIMENSIONI (cm.)  |  | COLORE   | ILLUMINABILE   | IMBALLO   |
|--------------------------|--|---|--|--|--|---|
| SDSK 133<br>(pag. 33)    | <b>SOPHIA</b><br>sedia   |    | L. 46<br>H. 87 - H. seduta 46<br>P. 59     | ● Neutro<br>N.B. Prodotto realizzabile a richiesta in qualsiasi colore (vedi pag. 125) | NO   |    |
| DSK 133<br>(pag. 33)     | <b>DESCUS</b><br>scrittoio<br>*PMMA INCLUSO                      |    | L. 130<br>H. 76<br>P. 60                   | ● Neutro<br>N.B. Prodotto realizzabile a richiesta in qualsiasi colore (vedi pag. 125) | NO   |    |
| LBA 83<br>(pag. 30)      | <b>MENSULA</b><br>libreria a giorno<br>desk                      |    | L. 86<br>H. 165<br>P. 40                   | ● Neutro<br>N.B. Prodotto realizzabile a richiesta in qualsiasi colore (vedi pag. 125) | NO   |    |
| DSK 50<br>(pag. 31)      | <b>WALLY</b><br>scaffale   |    | L. 50<br>H. 77<br>P. 58                    | ● Neutro<br>N.B. Prodotto realizzabile a richiesta in qualsiasi colore (vedi pag. 125) | NO   |    |
| LBA 40<br>(pag. 32)      | <b>WINDOW</b><br>scaffale  |    | L. 83<br>H. 83<br>P. 41                    | ● Neutro<br>N.B. Prodotto realizzabile a richiesta in qualsiasi colore (vedi pag. 125) | NO   |    |
| CILMU 40<br>(pag. 34)    | <b>TUNISI</b><br>tavolino / seduta<br>*PMMA INCLUSO<br>(Plexi 7) |   | Ø 40<br>H. 60<br>Ø 75 con Plexi 7          | ● Neutro<br>N.B. Prodotto realizzabile a richiesta in qualsiasi colore (vedi pag. 125) | KIT LED 1<br>oppure<br>KIT LED 1 RGB BT<br>a richiesta | IN BUSTA  |
| POUF 60<br>(pag. 35)     | <b>TABASCO</b><br>seduta con cuscino                             |  | Ø 60 - Ø seduta 35<br>H. 47 - H. seduta 47 | ● Neutro<br>N.B. Prodotto realizzabile a richiesta in qualsiasi colore (vedi pag. 125) | KIT LED 1<br>oppure<br>KIT LED 1 RGB BT<br>a richiesta |  |
| LMAB 175 SK<br>(pag. 37) | <b>MERLINO</b><br>lampada<br>appendiabiti                        |  | L. 50<br>H. 172<br>P. 50                   | ● Neutro<br>N.B. Prodotto realizzabile a richiesta in qualsiasi colore (vedi pag. 125) | NO   |  |
| LMAB 175<br>(pag. 37)    | <b>MERLINO</b><br>lampada<br>appendiabiti                        |  | L. 50<br>H. 172<br>P. 50                   | ● Neutro<br>N.B. Prodotto realizzabile a richiesta in qualsiasi colore (vedi pag. 125) | KIT LED NEON<br>incluso                                |  |
| TVBS 75<br>(pag. 37)     | <b>CURACAO</b><br>tavolino da salotto                            |  | L. 70<br>H. 42<br>P. 40                    | ● Bianco<br>N.B. Prodotto realizzabile a richiesta in qualsiasi colore (vedi pag. 125) | NO   |  |











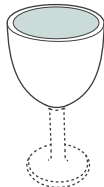

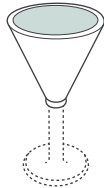



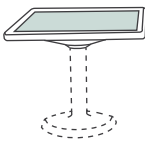

# Planters (pag. da 42 a 67)

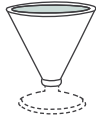



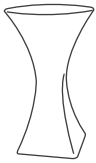

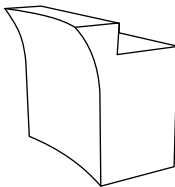

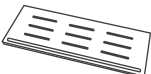

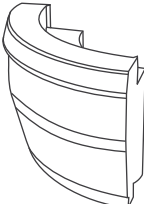

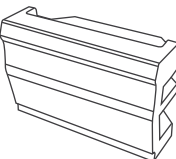
| CODICE                      | PRODOTTO                      | DIMENSIONI (cm.)  |  | COLORE   | ILLUMINABILE   | IMBALLO   |
|-----------------------------|-------------------------------|---|--|--|--|---|
| CUBL PV 50<br>(pag. 43)     | <b>CUBA</b><br>portavaso      |    | L. 50<br>H. 48<br>P. vano interno 20           | ● Neutro<br>N.B. Prodotto realizzabile a richiesta in qualsiasi colore (vedi pag. 125) | KIT LED 1<br>oppure<br>KIT LED 1 RGB BT<br>a richiesta |    |
| QLH PV 80<br>(pag. 42)      | <b>SANTIAGO</b><br>portavaso  |    | L. 40<br>H. 80<br>P. 40<br>P. vano interno 31  | ● Neutro<br>N.B. Prodotto realizzabile a richiesta in qualsiasi colore (vedi pag. 125) | KIT LED 1<br>oppure<br>KIT LED 1 RGB BT<br>a richiesta |    |
| VASNO 75 L<br>(pag. 44)     | <b>PORTORICO</b><br>portavaso |    | Ø. 75<br>H. 40<br>P. vano interno 28           | ● Neutro<br>N.B. Prodotto realizzabile a richiesta in qualsiasi colore (vedi pag. 125) | KIT LED 1<br>oppure<br>KIT LED 1 RGB BT<br>a richiesta |    |
| DP CMFS 65<br>(pag. 62-63)  | <b>DUBAI</b><br>portavaso     |    | Ø 65<br>H. 70<br>P. vano interno 35            | ● Neutro<br>N.B. Prodotto realizzabile a richiesta in qualsiasi colore (vedi pag. 125) | KIT LED 1<br>oppure<br>KIT LED 1 RGB BT<br>a richiesta |    |
| DP CMFS 85                  |                               |   | Ø 85<br>H. 90<br>P. vano interno 35            |  |  |   |
| CMFS 125                    |                               |   | Ø 118<br>H. 129<br>Parete singola              |  |  |   |
| CVA PV 90<br>(pag. 45)      | <b>HONOLULU</b><br>portavaso  |   | L. 59<br>H. 90<br>P. 59<br>P. vano interno 40  | ● Neutro<br>N.B. Prodotto realizzabile a richiesta in qualsiasi colore (vedi pag. 125) | KIT LED 1<br>a richiesta                               |   |
| TROBO PV 90<br>(pag. 46)    | <b>MONTERO</b><br>portavaso   |  | Ø 63<br>H. 90<br>P. vano interno 40            | ● Neutro<br>N.B. Prodotto realizzabile a richiesta in qualsiasi colore (vedi pag. 125) | KIT LED 1<br>a richiesta                               |  |
| TROBO PV 110                |                               |   | Ø 63<br>H. 110<br>P. vano interno 40           |  |  |   |
| TROBO PV 130                |                               |   | Ø 63<br>H. 130<br>P. vano interno 40           |  |  |   |
| CRA PV 105<br>(pag. 58-59)  | <b>RECIFE</b><br>portavaso    |  | Ø. 51<br>H. 105<br>P. vano interno 33          | ● Neutro<br>N.B. Prodotto realizzabile a richiesta in qualsiasi colore (vedi pag. 125) | KIT LED 1<br>a richiesta                               |  |
| PIFA PV 105<br>(pag. 60-61) | <b>GIZA</b><br>portavaso      |  | L. 50<br>H. 105<br>P. 50<br>P. vano interno 30 | ● Neutro<br>N.B. Prodotto realizzabile a richiesta in qualsiasi colore (vedi pag. 125) | KIT LED 1<br>a richiesta                               |  |
| COFA PV 120<br>(pag. 48-49) | <b>MANAUS</b><br>portavaso    |  | Ø 55<br>H. 120<br>P. vano interno 40           | ● Neutro<br>N.B. Prodotto realizzabile a richiesta in qualsiasi colore (vedi pag. 125) | KIT LED 1<br>a richiesta                               |  |
| PRIBO PV 120<br>(pag. 54)   | <b>BAHAMAS</b><br>portavaso   |  | L. 53<br>H. 120<br>P. 53<br>P. vano interno 40 | ● Neutro<br>N.B. Prodotto realizzabile a richiesta in qualsiasi colore (vedi pag. 125) | KIT LED 1<br>a richiesta                               |  |

| CODICE                          | PRODOTTO  | DIMENSIONI (cm.) |  | COLORE   | ILLUMINABILE  | IMBALLO  |
|---------------------------------|---|------------------|--|--|---|----------|
| NOVOLO 50<br>(pag. 47)          | <b>COZUMEL</b><br>portavaso   |                  | L. 50<br>H. 70<br>P. 40  | ● Neutro<br>N.B. Prodotto realizzabile a richiesta in qualsiasi colore (vedi pag. 125) | KIT LED 1<br>oppure<br>KIT LED 1 RGB BT<br>a richiesta      | IN BUSTA |
| CDK PV 110<br>(pag. 50-51)      | <b>FLORIDA</b><br>portavaso   |                  | L. 54<br>H. 112<br>P. 129  | ● Neutro<br>N.B. Prodotto realizzabile a richiesta in qualsiasi colore (vedi pag. 125) | KIT LED 1<br>a richiesta                                    |          |
| CDK PV 110 VS                   | Portavaso interno<br>per Florida<br>(dotato di 2 convogliatori acqua verso la base) |                  | L. 24<br>H. 54<br>P. 74  | ● Neutro<br>N.B. Prodotto realizzabile a richiesta in qualsiasi colore (vedi pag. 125) | ----  |          |
| RBS PV 30<br>(pag. 56-57)       | <b>FLORES</b><br>portavaso<br>libreria  |                  | L. 148 - L. interno 30<br>H. 31 - H. interno 23<br>P. 49 - P. interno 30 | ● Neutro<br>N.B. Prodotto realizzabile a richiesta in qualsiasi colore (vedi pag. 125) | KIT LED 7<br>a richiesta                                    |          |
| CUBL 30<br>per RBS<br>(pag. 59) | <b>VIAREGGIO</b><br>vaso  |                  | L. 30<br>H. 30<br>P. 30  | ● Marrone  | ----  |          |
| VALPO PV 60<br>(pag. 64)        | <b>TOLMEZZO</b><br>portavaso  |                  | L. 57<br>H. 61<br>P. 33<br>P. vano interno 24                            | ● Neutro<br>N.B. Prodotto realizzabile a richiesta in qualsiasi colore (vedi pag. 125) | KIT LED 1<br>oppure<br>KIT LED 1 RGB BT<br>a richiesta      | IN BUSTA |
| VALMO PV 55<br>(pag. 65)        | <b>TARVISIO</b><br>portavaso  |                  | L. 74<br>H. 61<br>P. 45<br>P. vano interno 24                            | ● Neutro<br>N.B. Prodotto realizzabile a richiesta in qualsiasi colore (vedi pag. 125) | KIT LED 1<br>oppure<br>KIT LED 1 RGB BT<br>a richiesta      | IN BUSTA |
| MLC 95<br>(pag. 52)             | <b>NIAGARA</b><br>vaso quadruplo  |                  | Ø 95<br>H. 60  | ● Neutro<br>N.B. Prodotto realizzabile a richiesta in qualsiasi colore (vedi pag. 125) | NO  | IN BUSTA |
| MLQ 74<br>(pag. 53)             | <b>VICTORIA</b><br>vaso quadruplo   |                  | L. 74<br>H. 60<br>P. 74  | ● Neutro<br>N.B. Prodotto realizzabile a richiesta in qualsiasi colore (vedi pag. 125) | NO  | IN BUSTA |
| CALGU 90<br>(pag. 55)           | <b>GAUDI'</b><br>Calice portavaso   |                  | L. 50<br>H. 40<br>P. 60  | ● Neutro<br>N.B. Prodotto realizzabile a richiesta in qualsiasi colore (vedi pag. 125) | KIT LED 1<br>oppure<br>KIT LED 1 RGB BT o CV<br>a richiesta |          |

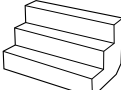

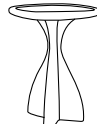















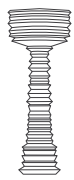

## Lounge Furniture (pag. da 68 a 89)

| CODICE                       | PRODOTTO                                     | DIMENSIONI (cm.) |                         | COLORE   | ILLUMINABILE   | IMBALLO |
|------------------------------|--|------------------|-------------------------|--|--|---------|
| ETOILE 80 V<br>(pag. 13)     | <b>ETOILE</b><br>tavolino<br>*PMMA INCLUSO   |                  | L. 78<br>H. 40<br>P. 78 | ● Neutro<br>N.B. Prodotto realizzabile a richiesta in qualsiasi colore (vedi pag. 125) | KIT LED 1<br>oppure<br>KIT LED 1 RGB BT<br>a richiesta |         |
| CLMD 40<br>(pag. 10-11)      | <b>TOBAGO</b><br>tavolino<br>*PMMA INCLUSO   |                  | Ø 60<br>H. 40           | ● Neutro<br>N.B. Prodotto realizzabile a richiesta in qualsiasi colore (vedi pag. 125) | KIT LED 1<br>oppure<br>KIT LED 1 RGB BT<br>a richiesta |         |
| CLMD 65<br>(pag. 21)         |  |                  | Ø 60<br>H. 65           |  |  |         |
| DP CMFS 65 V<br>(pag. 14-15) | <b>TRINIDAD</b><br>tavolino<br>*PMMA INCLUSO |                  | Ø 73<br>H. 55           | ● Neutro<br>N.B. Prodotto realizzabile a richiesta in qualsiasi colore (vedi pag. 125) | KIT LED 1<br>a richiesta                               |         |





| CODICE                      | PRODOTTO  | DIMENSIONI (cm.)  |  | COLORE  | ILLUMINABILE   | IMBALLO   |
|-----------------------------|---|---|--|---|--|---|
| VIN 60<br>(pag. 70-71)      | <b>WINE</b><br>calice<br>*PMMA INCLUSO                          |    | Ø 60<br>H. 60<br>H. 113 (con GMB 60)             | ● Neutro<br>N.B. Prodotto realizzabile a richiesta in qualsiasi colore (vedi pag. 125)  | GMB 60<br>oppure<br>GMB 60 RGB BT<br>a richiesta     |    |
| MRG 60<br>(pag. 68-69)      | <b>MARGARITA</b><br>calice<br>*PMMA INCLUSO                     |    | Ø 60<br>H. 60<br>H. 114 (con GMB 60)             | ● Neutro<br>N.B. Prodotto realizzabile a richiesta in qualsiasi colore (vedi pag. 125)  | GMB 60<br>oppure<br>GMB 60 RGB BT<br>a richiesta     |    |
| TVC 80<br>(pag. 72-73)      | <b>ANTIGUA</b><br>tavolino<br>*PMMA INCLUSO                     |    | Ø 80<br>H. 19<br>H. 74 (con gambo GMB)<br>P. 80  | ● Neutro<br>N.B. Prodotto realizzabile a richiesta in qualsiasi colore (vedi pag. 125)  | GMB 60 BL<br>oppure<br>GMB 60 RGB BT<br>a richiesta  |    |
| TVQ 80<br>(pag. 74-75)      | <b>BARBADOS</b><br>tavolino<br>*PMMA INCLUSO                    |    | L. 80<br>H. 19<br>H. 74 (con gambo GMB)<br>P. 80 | ● Neutro<br>N.B. Prodotto realizzabile a richiesta in qualsiasi colore (vedi pag. 125)  | GMB 60 BL<br>oppure<br>GMB 60 RGB BT<br>a richiesta  |    |
| GMB 60 SK                   | Gambo<br>per tavolini<br>per calici<br>per lampada Blob         |   | Ø 49<br>H. 57,5                                  | ● Neutro ● Nero   | ----   |   |
| GMB 60                      |   |   |  |   | KIT LED<br>INCLUSO                                   |   |
| GMB 60 RGB BT               |   |   |  |   | KIT LED RGB BT<br>INCLUSO                            |   |
| GMB 60 BL**                 |   |   |  |   | KIT LED BULBO<br>INCLUSO                             |   |
| MRG 60<br>(pag. 69)         | <b>MARTINICA</b><br>tavolino basso<br>*PMMA INCLUSO             |  | Ø 60<br>H. 60<br>H. 74 con GMB 60 B              | ● Neutro<br>N.B. Prodotto realizzabile a richiesta in qualsiasi colore (vedi pag. 125)  | GMB 60 B<br>oppure<br>GMB 60 B RGB BT<br>a richiesta |  |
| GMB 60 B                    | Gambo per tavolino<br>Martinica                                 |  | Ø 49<br>H. 22                                    | ● Neutro ● Nero   | KIT LED<br>INCLUSO                                   |  |
| GMB 60 B<br>RGB BT          |   |   |  |   | KIT LED RGB BT<br>INCLUSO                            |   |
| TVLH 110 SK<br>(pag. 76-77) | <b>BRAZIL</b><br>tavolino<br>*PMMA INCLUSO                      |  | Ø 67<br>H. 110<br>Base 48x48                     | ● Neutro<br>N.B. Prodotto realizzabile a richiesta in qualsiasi colore (vedi pag. 125)  | ----   |  |
| TVLH 110<br>(pag. 76-77)    |   |   |  |   | KIT NEON<br>INCLUSO                                  |   |
| BNR 120<br>(pag. 78-79)     | <b>ROBINSON</b><br>bancone bar                                  |  | L. 120<br>H. 111<br>P. 80                        | ● Neutro<br>N.B. Prodotto realizzabile a richiesta in qualsiasi colore (vedi pag. 125)<br><br>Solo NEUTRO per le versioni LED | ----   |  |
| BNR 120 LED<br>(pag. 78-79) | WS<br>workstation<br>con piano lavoro e<br>accessori in acciaio |   |  |   | KIT LED<br>incluso                                   |   |
| BNR 120 WS<br>(pag. 79)     | ----  |   |  |   |  |   |
| BNR 120 WS LED<br>(pag. 79) | KIT LED<br>incluso  |   |  |   |  |   |
| RIPBN 107                   | Ripiano per bancone<br>Robinson (2 perni<br>fissaggio inclusi)  |  | L. 107<br>H. 8<br>P. 39                          | ● Neutro<br>N.B. Prodotto realizzabile a richiesta in qualsiasi colore (vedi pag. 125)  | ----   | IN BUSTA  |

| CODICE   | PRODOTTO  | DIMENSIONI (cm.)  |                           | COLORE  | ILLUMINABILE  | IMBALLO   |
|--|---|---|---------------------------|---|---|---|
| BNA 180<br>(pag. 80-81 / 84-85)  | <b>PEMBA</b><br>bancone bar<br>angolare                         |    | L. 181<br>H. 110<br>P. 80 | ● Neutro<br>N.B. Prodotto realizzabile a richiesta in qualsiasi colore (vedi pag. 121)  | ---   |    |
| BNA 180 KIT LED<br>(con luce LED)  |   |   |                           |   | KIT LED INCLUSO   |   |
| BNA 180 RGB<br>(con luce LED RGB Master)   |   |   |                           |   | KIT LED 1 RGB INCLUSO                                       |   |
| BNA 180 RGB SL<br>(con luce LED RGB Slave)   |   |   |                           |   | KIT LED 1 RGB INCLUSO                                       |   |
| <b>N.B. Per illuminazione sincronizzata è possibile abbinare a n. 1 MASTER massimo n. 3 SLAVE</b>  |   |   |                           |   |   |   |
| BNC 170<br>(pag. 82-83 / 84-85)  | <b>ZANZIBAR</b><br>bancone bar                                  |    | L. 170<br>H. 110<br>P. 92 | ● Neutro<br>N.B. Prodotto realizzabile a richiesta in qualsiasi colore (vedi pag. 121)<br><br>Solo NEUTRO per le versioni LED | ---   |    |
| BNC 170 KIT LED<br>(con luce LED)  |   |   |                           |   | KIT LED INCLUSO   |   |
| BNC 170 RGB<br>(con luce LED RGB Master)   |   |   |                           |   | KIT LED 1 RGB INCLUSO                                       |   |
| BNC 170 RGB SL<br>(con luce LED RGB Slave)   |   |   |                           |   | KIT LED 1 RGB INCLUSO                                       |   |
| BNC 170 WS<br>(pag. 83)  | WS<br>workstation<br>con piano lavoro e<br>accessori in acciaio |   |                           |   | ---   |   |
| BNC 170 WS KIT LED<br>(con luce LED)   |   |   |                           |   | KIT LED INCLUSO   |   |
| RIPZR 99   | Ripiano in legno multistrato                                    |   | L. 99<br>P. 54<br>H. 2    | ● Bianco  | /   | Busta   |
| <b>N.B. La serie BNC 170 è fornita completa di *PMMA per i ripiani superiori e inferiori</b>  |   |   |                           |   |   |   |
|  |   |   |                           |   | <b>*PMMA = Piano in plexyglass</b>                          |   |
| MENS 15<br>(pag. 86)   | <b>BRILLO</b><br>espositore bottiglie                           |  | L. 60<br>H. 51<br>P. 51   | ● Neutro<br>N.B. Prodotto realizzabile a richiesta in qualsiasi colore (vedi pag. 121)  | KIT LED 1<br>oppure<br>KIT LED 1 RGB BT o CV<br>a richiesta |  |
| TVHP 105<br>(pag. 87)  | <b>HIPPY</b><br>tavolino alto                                   |  | L. 71<br>H. 107<br>P. 71  | ● Bianco ● Tortora<br>N.B. Prodotto realizzabile a richiesta in qualsiasi colore (vedi pag. 121)                              | ---   |  |
| SGL 3681<br>(pag. 87)  | <b>HIPPY</b><br>sgabello  |  | L. 60<br>H. 51<br>P. 51   | ● Bianco ● Tortora<br>N.B. Prodotto realizzabile a richiesta in qualsiasi colore (vedi pag. 121)                              | ---   |  |



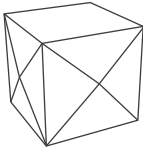

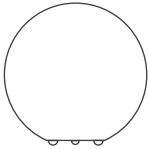

# Light Design *(pag. da 90 a 105)*

| CODICE                                   | PRODOTTO   | DIMENSIONI (cm.)  |                                       | COLORE   | ILLUMINABILE   | IMBALLO   |
|--|--|---|---------------------------------------|--|--|---|
| FLT 43<br><i>(pag. 90)</i>               | <b>FLUTE</b><br>lampada  |    | Ø 43<br>H. 108<br>H. 182 (con GMB 76) | ○ Neutro<br>N.B. Prodotto realizzabile a richiesta in qualsiasi colore (vedi pag. 125) | GMB 76<br>a richiesta  |    |
| HST 80<br><i>(pag. 91)</i>               | <b>HISTOIRE</b><br>lampada   |    | Ø 45<br>H. 80<br>H. 154 (con GMB 76)  | ○ Neutro<br>N.B. Prodotto realizzabile a richiesta in qualsiasi colore (vedi pag. 125) | GMB 76<br>a richiesta  |    |
| GMB 76                                   | Gambo<br>per lampade<br>Blob / Flute / Histoire  |    | Ø 49<br>H. 76                         | ○ Neutro ● Nero  | KIT LED<br>incluso   |    |
| LTR 180<br><i>(pag. 99)</i>              | <b>TOWER</b><br>lampada  |    | L. 28<br>H. 178<br>P. 28              | ○ Neutro<br>N.B. Prodotto realizzabile a richiesta in qualsiasi colore (vedi pag. 125) | KIT LUCE NEON<br>INCLUSO   |    |
| LTC 180<br><i>(pag. 98)</i>              | <b>LIGHTHOUSE</b><br>lampada   |   | Ø 33<br>H. 177                        | ○ Neutro<br>N.B. Prodotto realizzabile a richiesta in qualsiasi colore (vedi pag. 125) | KIT LUCE NEON<br>INCLUSO   |   |
| SASSO 3<br><i>(pag. 102)</i>             | <b>MATERA</b><br>lampada<br>contenitore  |  | L. 58<br>H. 50<br>P. 43               | ○ Neutro<br>N.B. Prodotto realizzabile a richiesta in qualsiasi colore (vedi pag. 125) | KIT LED 3<br>a richiesta   | IN BUSTA  |
| LMTB 140<br>LMTS 78<br><i>(pag. 100)</i> | <b>ANDROMEDA</b><br>lampada  |  | L. 78<br>H. 188<br>P. 78              | ○ Neutro<br>N.B. Prodotto realizzabile a richiesta in qualsiasi colore (vedi pag. 125) | KIT LUCE NEON<br>INCLUSO   |  |
| LMGR 180<br><i>(pag. 101)</i>            | <b>NEW YORK</b><br>lampada   |  | L. 44<br>H. 182<br>P. 44              | ○ Neutro<br>N.B. Prodotto realizzabile a richiesta in qualsiasi colore (vedi pag. 125) | KIT LUCE NEON<br>INCLUSO   |  |
| CNTA 45<br><i>(pag. 94)</i>              | <b>VIDA</b><br>lampada/centrotavola<br>(Kit sospensione con<br>portalampada a richiesta) |  | Ø 43<br>H. 23                         | ○ Neutro<br>N.B. Prodotto realizzabile a richiesta in qualsiasi colore (vedi pag. 125) | KIT LED 1<br>KIT LED 1 RGB BT<br>KIT LED RGB 3 BT*<br>*tenuta stagna idoneo<br>al galleggiamento | IN BUSTA<br><br>Conf. 4 pezzi<br>monocolore   |
| APL 40<br><i>(pag. 95)</i>               | <b>LUCIO</b><br>lampada / applique   |  | L. 40<br>H. 40<br>P. 8,5              | ○ Neutro<br>N.B. Prodotto realizzabile a richiesta in qualsiasi colore (vedi pag. 125) | KIT LED<br>INCLUSO   |  |
| APL 40 SK<br><i>(pag. 95)</i>            | <b>LUCIO</b><br>lampada / applique   |  | L. 40<br>H. 40<br>P. 8,5              | ○ Neutro<br>N.B. Prodotto realizzabile a richiesta in qualsiasi colore (vedi pag. 125) | /  |  |
| LMS 60<br><i>(pag. 96-97)</i>            | <b>SIRIO</b><br>lampada / tavolino<br>(Kit sospensione con<br>portalampada a richiesta)  |  | Ø 60<br>H. 43                         | ○ Neutro<br>N.B. Prodotto realizzabile a richiesta in qualsiasi colore (vedi pag. 125) | KIT LED 1<br>oppure<br>KIT LED 1 RGB BT<br>a richiesta   |  |

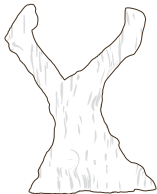













| CODICE                 | PRODOTTO                              | DIMENSIONI (cm.)  |                       | COLORE  | ILLUMINABILE   | IMBALLO   |
|------------------------|---------------------------------------|---|-----------------------|---|--|---|
| CDMD 25<br>(pag. 9/69) | <b>DIAMANTE</b><br>lampada / tavolino |  | L. 24 - H. 22 - P. 25 | ● Neutro<br>N.B. Prodotto realizzabile a richiesta<br>in qualsiasi colore (vedi pag. 125) | KIT LED 1<br>oppure<br>KIT LED 1 RGB BT<br>a richiesta |  |
| CDMD 30                |                                       |   | L. 28 - H. 26 - P. 30 |   |  |   |
| CDMD 40                |                                       |   | L. 40 - H. 38 - P. 40 |   |  |   |
| CDMD 50                |                                       |   | L. 50 - H. 48 - P. 50 |   |  |   |
| CDMD 60                |                                       |   | L. 60 - H. 60 - P. 60 |   |  |   |
| SFM 30<br>(pag. 92-93) | <b>BALUX</b><br>lampada a sfera       |  | Ø 30 - H. 26,5        | ● Neutro<br>N.B. Prodotto realizzabile a richiesta<br>in qualsiasi colore (vedi pag. 125) | KIT LED 1<br>oppure<br>KIT LED 1 RGB BT<br>a richiesta |  |
| SFM 40                 |                                       |   | Ø 40 - H. 37          |   |  |   |
| SFM 50                 |                                       |   | Ø 50 - H. 48          |   |  |   |
| SFM 70                 |                                       |   | Ø 70 - H. 68          |   |  |   |
| SFM 90                 |                                       |   | Ø 90 - H. 89          |   |  |   |

## Ornament (pag. da 106 a 113)

| CODICE                      | PRODOTTO                                  | DIMENSIONI (cm.)  |                                | COLORE  | ILLUMINABILE   | IMBALLO   |
|-----------------------------|---|---|--------------------------------|---|--|---|
| ULIVO 328<br>(pag. 104-105) | <b>OLIVO</b><br>albero                    |  | L. 224/260<br>H. 328<br>P. 160 | ● Neutro<br>N.B. Prodotto realizzabile a richiesta in<br>qualsiasi colore (vedi pag. 125) | KIT a richiesta<br>non ancora disponibile              | BUSTA   |
| ALB 110<br>(pag. 106-107)   | <b>ALASKA</b><br>scultura                 |  | Ø 74<br>H. 110                 | ● Neutro<br>N.B. Prodotto realizzabile a richiesta in<br>qualsiasi colore (vedi pag. 125) | KIT LED 1<br>oppure<br>KIT LED 1 RGB BT<br>a richiesta |  |
| PICLA 40<br>(pag. 107)      | <b>CASTEL VOLTURNO</b><br>base per Alaska |  | Ø 40<br>H. 48                  | Neutro<br>N.B. Prodotto realizzabile a richiesta in<br>qualsiasi colore (vedi pag. 125)   | In abbinamento<br>ad ALB 110<br>solo KIT LED 1 RGB BT  | IN BUSTA  |
| PRNP 65<br>(pag. 108)       | <b>PEPERONE</b><br>scultura               |  | Ø. 65<br>H. 71                 | ● Neutro<br>N.B. Prodotto realizzabile a richiesta in<br>qualsiasi colore (vedi pag. 125) | KIT LED 1<br>oppure<br>KIT LED 1 RGB BT<br>a richiesta |  |
| TR 3<br>(pag. 109)          | <b>VENERE DI MILO</b><br>scultura         |  | L. 54<br>H. 104<br>P. 36       | ● Neutro<br>N.B. Prodotto realizzabile a richiesta in<br>qualsiasi colore (vedi pag. 125) | KIT LED 1<br>oppure<br>KIT LED 1 RGB BT<br>a richiesta | IN BUSTA  |

# Accessories

| CODICE   | PRODOTTO  | DIMENS. (cm.)    | COL.    | IMBALLO   |
|--|---|------------------|---------|---|
| <b>KIT LUCE</b> (In alternativa al KIT LED 1)<br>(Portalampada singolo per tutti i modelli predisposti)<br>IP 65   |    | ----             | ----    | IN BUSTA  |
| <b>KIT LED 1</b><br>(LED singolo per tutti i modelli predisposti)<br>IP 66   |    |                  |         |   |
| <b>KIT LED 3</b><br>(LED per SASSO 3)<br>IP 66   |    |                  |         |   |
| <b>KIT LED 5</b><br>(LED doppio idoneo per divani CAIRO e MIAMI)<br>IP 66  |    | ----             | ----    | IN BUSTA  |
| <b>KIT LED 4</b><br>(LED triplo idoneo per divano ACAPULCO)<br>IP 66   |    |                  |         |   |
| <b>KIT LED 7</b><br>(LED quadruplo idoneo per portavaso/libreria FLORES)<br>IP 66  |    |                  |         |   |
| <b>KIT LED RGB 1 BT</b><br>(LED singolo per tutti i modelli predisposti,<br>con accumulatore e trasformatore)<br>IP 68   |   | ----             | ----    |   |
| <b>KIT LED RGB 3 BT</b> <b>TENUTA STAGNA</b><br>(LED singolo per modelli SFM 30-40-50 e CNTA 45,<br>a tenuta stagna e idoneo a galleggiare con accu-<br>mulatore e trasformatore)<br>IP 68 |  | ----             | ----    |  |
| <b>KIT LED RGB 10 CV</b><br>(LED singolo per tutti i modelli predisposti,<br>con cavo di alimentazione)<br>IP 66   |  | ----             | ----    |  |
| <b>KIT FISSAGGIO PRATO S</b>   |  | Per SFM 30-40    | Acciaio | IN BUSTA  |
| <b>KIT FISSAGGIO PRATO L</b>   |   | Per SFM 50-70-90 |         |   |
| <b>KIT SOSP. LG</b><br>con portalampada E27<br>Per sfere BALUX 70 e 90<br>cavo 1,5 m.  |  | ----             | ----    | IN BUSTA  |
| <b>KIT SOSP. SM</b><br>con portalampada E 27<br>Per sfere BALUX 30 - 40 - 50 / VIDA / SIRIO<br>cavo 1,5 m.   |  | ----             | ----    | IN BUSTA  |

modum®  
ITALIAN COMFORTABLE FASHION

# COLOURS

|    |            |
|----|------------|
| NE | NEUTRO     |
| BI | BIANCO     |
| 94 | THE' VERDE |
| 97 | CIPRIA     |
| 89 | TURCHESE   |
| 78 | TORTORA    |
| 84 | ANICE      |
| 95 | AVIO       |
| RF | FRAGOLA    |
| 71 | COOL GREY  |
| 70 | CHERRY     |
| I  | SMOKE      |

# modum

## PRODUCT FEATURES

 Design Italiano, versatilità, funzionalità e praticità. La linea MODUM è realizzata in resine speciali di alta qualità con tecnologie d'avanguardia che conferiscono al prodotto caratteristiche eccezionali in un connubio di stile ed eleganza.

- Lavabili con detergenti comuni
- Resistenti agli urti
- Resistenti al gelo ed al solleone
- Colori stabilizzati anti UV
- Lunga vita

 Functional, practical and exclusive Italian Design. The MODUM items are made of high-quality resins using innovative technology with exceptional qualities combining fashion and elegance.

- Cleanable with usual cleaning product
- Shockproof
- Frost and heat resistant
- Colours are UV rays resistant
- Long life

 Design Italien, versatilité et fonctionnalité. Les produits de la ligne MODUM sont réalisés en résines d'haute qualité utilisant une technologie innovatrice qui lui confèrent des qualités exceptionnelles en combinant style et élégance.

- Lavables avec tous détergents
- Résistants aux chocs
- Résistants au froid et à la chaleur
- Couleurs résistantes aux rayons UV
- Longue durée

 Italienischem Design, vielfältigkeit, funktionalität und bequemlichkeit, hergestellt in speziellem hochqualitätsharz und mit erneuernden techniken, die in verbindung mit stil und eleganz den produkten aussergewöhnliche eigenschaften verleihen.

- Abwaschbar mit beliebigen reinigungsmitteln
- Stoßfest
- Hitze-und kältebeständig
- Farben sind UV
- Strahlen beständig
- Langlebig

 Diseño italiano, funcionalidad, comodidad: realizados en super-resina especial y tecnología punta que confieren al producto características excepcionales.

- Lavable con detergente común
- Resistentes a los golpes
- Resistente al frío y al calor
- Colores que no se degradan con el sol
- Duraderos

# INDICE / INDEX

**modum**<sup>®</sup>  
ITALIAN COMFORTABLE FASHION

furniture / 2  
planters / 40  
lounge furniture / 66  
light design / 88  
ornament / 103

---

|         |                 |                |               |
|---------|-----------------|----------------|---------------|
| 14_15   | acapulco        | maui           | 16            |
| 106_107 | alaska          | medea          | 5_7           |
| 100     | andromeda       | mensula        | 30            |
| 72_73   | antigua         | merlino        | 37            |
| 54      | bahamas         | miami          | 12_13         |
| 92_93   | balux           | montero        | 46            |
| 17      | bangkok         | new york       | 101           |
| 74_75   | barbados        | niagara        | 52            |
| 38_39   | belize          | olivo          | 104_105       |
| 22_23   | bikini          | onda           | 26_27         |
| 76_77   | brazil          | panama         | 15            |
| 86      | brillo          | pemba          | 80_81 - 84_85 |
| 8_9     | cairo           | peperone       | 108           |
| 10_11   | caracas         | portorico      | 44            |
| 107     | castel volturno | recife         | 58_59         |
| 24_25   | copacabana      | robinson       | 78_79         |
| 47      | cozumel         | salito         | 79_83         |
| 43      | cuba            | samarcanda     | 18            |
| 37      | curaçao         | santiago       | 42            |
| 33      | descus          | scalea         | 36            |
| 9 / 69  | diamante        | simposio       | 4_7           |
| 62_63   | dubai           | sirio          | 96_97         |
| 13      | etoile          | sophia         | 33            |
| 56_57   | flores          | tabasco        | 35            |
| 50_51   | florida         | tahiti         | 20            |
| 90      | flute           | tarvisio       | 65            |
| 55      | gaudi           | tobago         | 20 - 21       |
| 60_61   | giza            | tolmezzo       | 64            |
| 87      | hippy           | tower          | 99            |
| 91      | histoire        | trinidad       | 15            |
| 45      | honolulu        | tunisi         | 34            |
| 19      | jamaica         | venere di milo | 109           |
| 28_29   | le mans         | viareggio      | 57            |
| 98      | lighthouse      | victoria       | 53            |
| 95      | lucio           | vida           | 94            |
| 48_49   | manaus          | wally          | 31            |
| 21      | manila          | window         | 32            |
| 68      | margarita       | wine           | 70_71         |
| 69      | martinica       | zanzibar       | 82_83 / 84_85 |
| 102     | matera          |                |               |

**modum**<sup>®</sup>  
ITALIAN COMFORTABLE FASHION  
by **Telcom**<sup>®</sup>

*N.B.*

*I dati e le immagini riportate in questo catalogo sono indicativi.*

*La Telcom si riserva il diritto di apportare eventuali variazioni o migliorie agli articoli senza preavviso.*

*Le misure sono espresse in centimetri con tolleranza del  $\pm 1,5\%$ .*

*The data and images provided in this catalogue are intended for illustrative purpose only.*

*Telcom reserves the right to make changes or revisions to its products at any time without prior notice.*

*The dimensions are expressed in centimeters within a range of  $\pm 1.5\%$*

---

Tutto il materiale contenuto in questo catalogo, compresi i testi, le fotografie, i disegni, è di proprietà della Telcom Spa e pertanto è protetto da leggi che tutelano la proprietà intellettuale. Per tale motivo non può essere utilizzato da alcuno senza esplicita autorizzazione scritta della Telcom Spa.

*All the material in this catalogue, (including texts, photos and drawings), belongs to Telcom Spa. Therefore it is protected by laws defending intellectual property. For this reason it cannot be used by anybody without the prior and written authorization of Telcom Spa.*





**Telcom Spa**

Via dell'Industria, 21  
72017 Ostuni (BR) ITALY

Tel. +39 0831 348 111 r.a.- Fax +39 0831 304 510  
telcom@telcomitalia.it - telcom@legalmail.it

[www.telcomitalia.it](http://www.telcomitalia.it)

